

# CONSTRUCTION WITH SURFACE BONDING

---

U.S. Department of Agriculture  
Agricultural Research Service  
Agriculture Information Bulletin No. 374

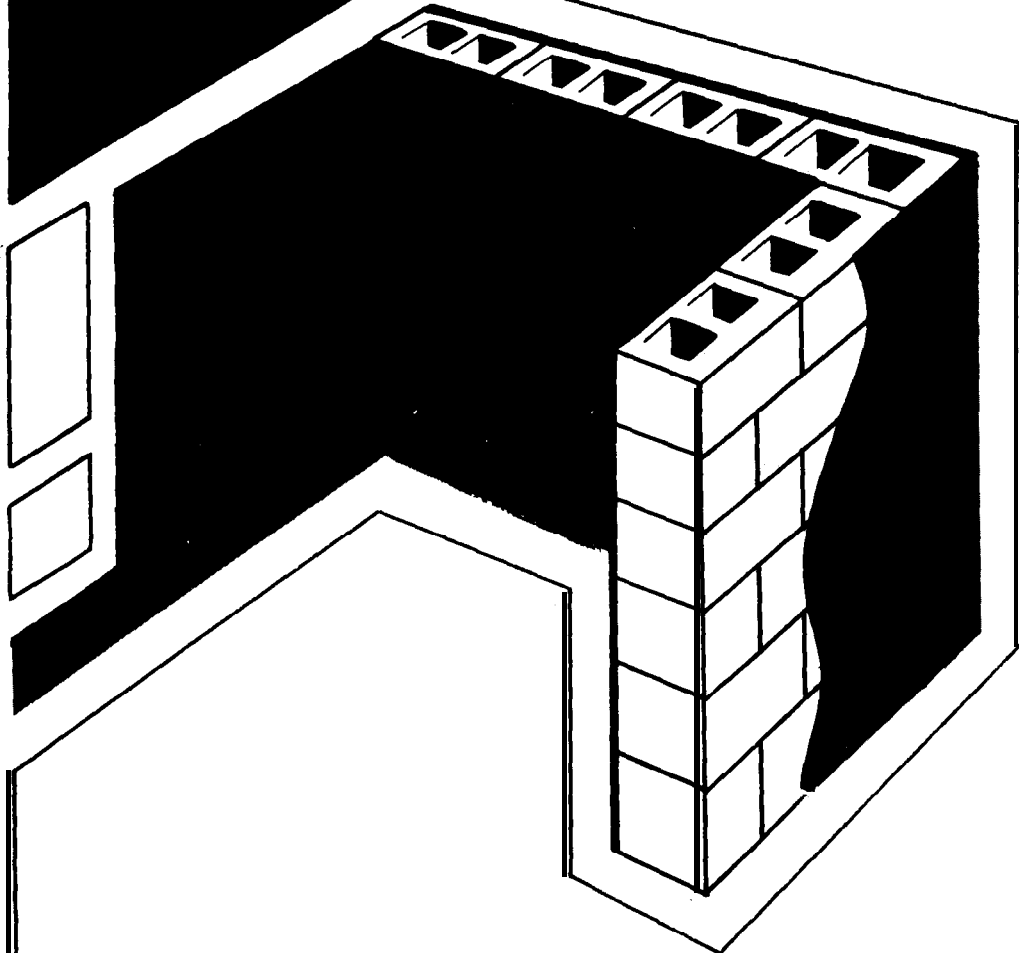

## CONTENTS

|                                       | <i>Page</i> |  | <i>Page</i> |
|---------------------------------------|-------------|--|-------------|
| Advantages of surface bonding .....   | 1           | Basement construction .....              | 12          |
| Preliminary planning .....            | 2           | Other construction details.....          | 13          |
| Preparation for surface bonding ..... | 3           | Pilasters .....                          | 13          |
| Foundation.. .....                    | 4           | Beams or joists .....                    | 13          |
| Tie-down rods .....                   | 5           | Surface bonding the walls .....          | 14          |
| Floor .....                           | 5           | Commercial surface bonding               |             |
| Erecting the walls .....              | 5           | premises .....                           | 14          |
| Tying intersecting walls .....        | 7           | Ingredients for home-mixed               |             |
| Control joints.....                   | 7           | surface bonding .....                    | 15          |
| Lintels and sills .....               | 8           | Home mixing the materials .....          | 15          |
| Windows and doors .....               | 8           | Applying the bonding <b>mix</b> .....    | 16          |
| Installing electrical switches        |             | Coverage of the bonding <b>mix</b> ..... | 17          |
| and outlets .....                     | 10          | Time requirements .....                  | 17          |
| Installing tie-down rods .....        | 11          | Sanded bonding <b>mix</b> .....          | 17          |
| Insulating the wall .....             | 11          | Painting surface-bonded walls .....      | 18          |
| Installing the plate .....            | 12          | CAUTION STATEMENT .....                  | 18          |

## PREFACE

Agricultural Research Service research on surface bonding began in 1967 and is being continued on a limited basis in cooperation with the Agricultural Engineering Department of the University of Georgia's College of Agriculture at College Station, Athens, Ga. The work contributes to Southern Regional Housing Research Project S-66, "Physical, Social, and Economic Aspects of Functional Housing for Low-Income Families," sponsored by the State Experiment Stations of Georgia, North Carolina, South Carolina, Texas, and Virginia, and the Agricultural Research Service, the Cooperative State Research Service, and the Forest Service of the U. S. Department of Agriculture.

Tests by the National Concrete Masonry Association show that surface bonded walls are strong enough for two-story construction. Commercial buildings with walls 14 feet high have been successfully constructed.

The E-type glass fiber used as reinforcing in the surface-bonding mix has, after application to test walls, shown no etching or loss of flexibility when exposed to the weather over a 39-month period. The regular type I gray cement used in the mix is much higher in alkalinity than white cement so that the reaction of the gray cement on the fibers would tend to be more severe. The fact that the fibers have withstood this reaction is evidence of probable continued durability under normal building conditions. The use of white cement would be an added safety factor.

An alkali-resistant fiber has been developed by one U.S. concern, and a bonding mix containing this fiber is on the market. The use of this fiber would be desirable under high-alkali conditions and continuous high-moisture exposure, such as in swimming pools and deep tanks.

The first Agricultural Research Service publication on surface bonding was issued January 1970 as Correspondence Aid 42-57, "Surface Bonding-A Technique for Erecting Concrete Block Walls Without Mortar Joints." This was superseded by U.S. Department of Agriculture Information Bulletin No. 343, "Surface Bonding of Concrete Blocks," in June 1970. The present edition of the bulletin is a complete revision incorporating more detailed instructions and the experience gained since the first publication.

Supersedes Agriculture Information Bulletin No. 343  
"Surface Bonding of Concrete Blocks"

# CONSTRUCTION WITH SURFACE BONDING

by

B. Carl Haynes, Jr., P.E., and J.W. Simons, P.E.<sup>1</sup>

## ADVANTAGES OF SURFACE BONDING

Surface bonding is both a material and a technique for erecting concrete-block walls without mortar joints. The bonding material is a cement-glass fiber mixture that is troweled on both sides of the stacked blocks to hold them together. No mortar is used between the blocks.

Normally, concrete blocks are laid in mortar. Contrary to popular belief, the mortar does not act as a "glue" to hold the blocks together. It serves mainly as a bed to aid in leveling the blocks. Mortar joints have little, if any, strength in tension and relatively poor adhesion. For structural purposes other than direct compression, the strength of a mortar joint is negligible.

Furthermore, mortar joints do not completely tighten the wall against the penetration of rain. The mortar joints actually serve as capillary wicks and draw moisture through the cracks between the mortar and the blocks. Being extremely porous, the blocks themselves also soak up water. Accordingly, a concrete block wall laid in mortar must be waterproofed by the application of a sealing compound.

In surface-bonded block walls, only the first course is bedded in mortar or bonding mix. This permits the accurate and rapid dry-stacking of subsequent courses.

Surface-bonded-or "skin-stressed"-concrete block walls are stronger and tighter than conventionally laid walls. When the surface bonding mixture on the wall has cured, it will have relatively high tensile strength and good adhesion to the wall. Any flexure of a wall section is resisted to the limit of the bonding-tensile strength, and that strength is generally about six times that of conventionally mortared block walls.<sup>2</sup> Also, the surface bonding mixture becomes a waterproof coating for the walls. (Swimming pools and deep tanks will need additional waterproofing such as special latex paint or epoxy paint.)

Another advantage of surface bonding is its economy: fewer hours are needed for wall construction, and less-skilled labor can be readily trained to apply surface bonding.<sup>3</sup>

Surface bonding offers a variety of "natural" color and finish possibilities. The walls can be permanently colored without painting by adding mortar color or concrete color to the bonding mix. The bonding material itself can dry to either a smooth or stucco-type finish depending on how it is applied.

---

**\*Extensive test data for surface bonding is contained in "Research Bulletin 110: Surface Bonding of Concrete Block Walls as Related to Structural Properties," published by the Agricultural Research Service, USDA, in cooperation with the University of Georgia. Copies of this bulletin can be obtained by writing Editor's Office, College of Agriculture Experiment Stations, University of Georgia, Athens, Ga. 30602.**

<sup>3</sup> National Concrete Masonry Association comparative tests, reported in NCMA-TEK 54, show that a mason's productivity is increased 70 percent by utilizing surface bonding in lieu of mortared construction.

---

<sup>1</sup>Both formerly Agricultural Engineers at the Housing and Environmental Engineering Laboratory in Athens, Ga.

Mr. Simons is retired. Mr. Haynes is currently Agricultural Engineer at the Environmental Engineering Laboratory, Richard B. Russell Agricultural Research Center, Southern Region, Agricultural Research Service, U.S. Department of Agriculture, P.O. Box 5671, Athens, Ga. 30604.

## PRELIMINARY PLANNING

Select a site that requires minimum excavation, has sufficient stability for the type of foundation proposed, has good drainage, and is not subject to flooding.

Plan for water supply and sewage disposal. This may require consultation with public health authorities.

Determine if a building permit is required in the area where you intend to build. Building codes may be administered by the city, county, or state. County offices can usually furnish permit information.

Decide who will be doing the actual construction work. Will you do all the construction, sub-contract part of the construction, or contract for the finished (complete) building?

Sub-contracting such items as a concrete slab floor, plumbing, and heating may be necessary to allow completion within desired time limits.

An accurate layout of the structure is essential before you begin to build (fig. 1). Keep in mind that without mortar joints the overall wall dimensions will not be modular, that is, on **8-inch** or **16-inch** centers. The lengths and heights of walls and wall openings constructed with standard-size blocks without mortar joints are given in the table. Since many blocks are not uniform in size and may often be tapered, add one-fourth inch to the lengths given in the table for each approximate 10 feet of wall.

**Dimensions of Walls and Wall Openings  
Constructed with Surface-Bonded Concrete Blocks<sup>1</sup>**

| Number<br>of<br>blocks | Length of wall<br>or<br>width of door<br>and window openings <sup>2</sup> | Number<br>of<br>courses | Height of wall<br>or<br>height of door<br>and window openings <sup>3</sup> |
|------------------------|---|-------------------------|--|
| 1                      | 1' 3 5/8"   | 1                       | 7 5/8"   |
| 2                      | 2' 7 1/4"   | 2                       | 1' 3 1/4"  |
| 3                      | 3' 10 7/8"  | 3                       | 1' 10 7/8"   |
| 4                      | 5' 2 1/2"   | 4                       | 2' 6 1/2"  |
| 5                      | 6' 6 1/8"   | 5                       | 3' 2 1/8"  |
| 6                      | 7' 9 3/4"   | 6                       | 3' 9 3/4"  |
| 7                      | 9' 1 3/8"   | 7                       | 4' 5 3/8"  |
| 8                      | 10' 5"  | 8                       | 5' 1"  |
| 9                      | 11' 8 5/8"  | 9                       | 5' 8 5/8"  |
| 10                     | 13' 0 1/4"  | 10                      | 6' 4 1/4"  |
| 11                     | 14' 3 7/8"  | 11                      | 6' 11 7/8"   |
| 12                     | 15' 7 1/2"  | 12                      | 7' 7 1/2"  |
| 13                     | 16' 11 1/8"   | 13                      | 8' 3 1/8"  |
| 14                     | 18' 2 3/4"  | 14                      | 8' 10 3/4"   |
| 15                     | 19' 6 3/8"  | 15                      | 9' 6 3/8"  |

Standard **16-inch** blocks, 15-5/8 inches long by 7-5/8 inches high.

<sup>2</sup>Add one-fourth-inch for each approximate 10 feet of wall to allow for nonuniformity in **size** of blocks.

<sup>3</sup>Make a trial stacking of blocks to determine the actual height of wall or opening before beginning construction.

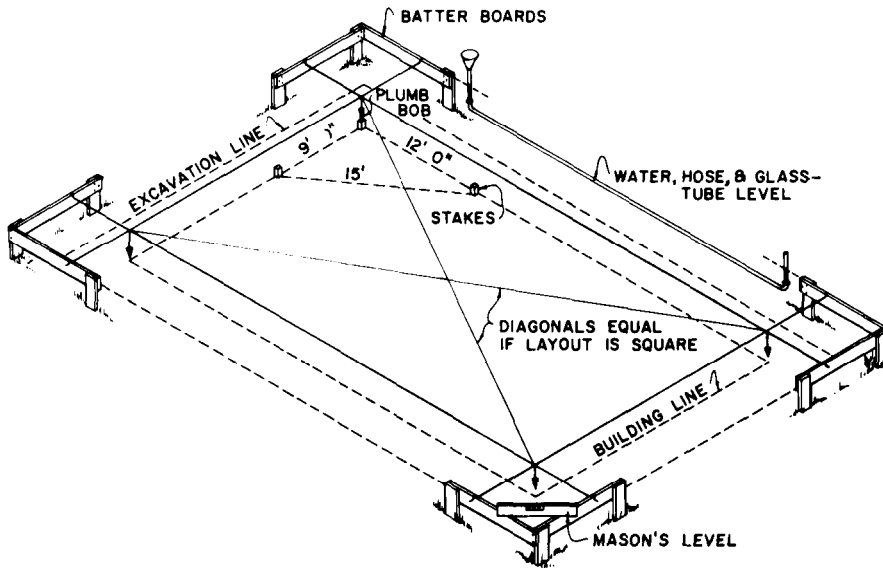

Figure 1.-Layout of the building must be accurate. Square building lines, marking with stakes at corners. Mark limits of excavation with stakes. Position, erect, and level batter boards 4 to 10 feet from excavation lines. (Excavation lines should be at a sufficient distance from building lines to allow workman to apply surface bonding.) Attach lines to batter boards above building lines. After excavation is complete, building corners can be located simply by dropping plumb line from lines on batter boards.

## PREPARATION FOR SURFACE BONDING

The following items are needed for stacking blocks and applying the surface bonding mixture:

- Wheelbarrow, small mortar box, or tub—to mix and hold the bonding mix.
- Garden cultivator, rake or weeding hoe (three- or four-tine)-to mix the dry ingredients together and with the water.
- Bricklayer's trowel-to aid mixing and to transfer the mix to hawk.
- Hawk (a small board or piece of square metal with a handle attached to the bottom)-to carry the bonding mix. (See fig. 2 for hawk designed especially for surface bonding.)
- Plasterer's trowel-to spread and smooth the bonding mix (3 1/2- by 12-inch or 4- by 14-inch is the most suitable).
- Garden hose with fine-spraying nozzle—to wet down the block wall before applying the bonding mix, and to spray water onto the bonded wall to aid in curing the mix.
- Carpenter's or mason's level-to check the walls to be sure they are horizontal and

vertical. Use the level at least every third course.

- Mason's line (tightly braided nylon or cotton cord with wooden hooks)-to **aline** the blocks in stacking the wall.
- Rubber-coated gloves-to protect the hands.

In addition, if holes are to be drilled and expansion bolts set into the cured concrete floor or footing for attachment of tie rods, some type of power-driven drill and a driving tool will be needed. Hammer drills are best for drilling concrete, but are often too expensive for small jobs or a single house. An ordinary electric drill with carbide-tipped masonry bit is slower but satisfactory. The drilling can be done with a star drill and hammer, but this requires more time. A drill, either hand or electric, and bits are needed for drilling holes in the plate to receive the rods and cables; if electric, the drill should be 1/2-inch size. General carpenter tools will be needed in other phases of the construction. A portable electric circular saw saves time and is a good investment.

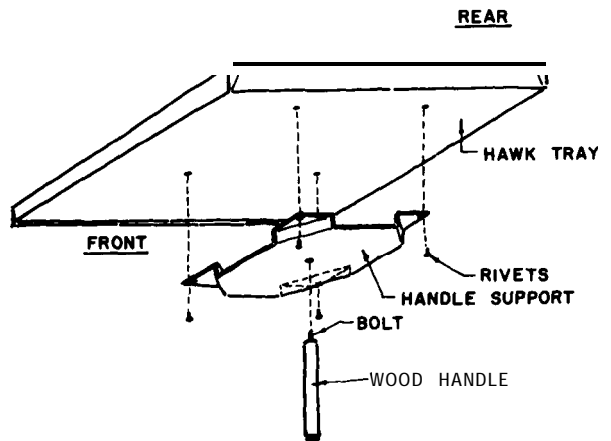
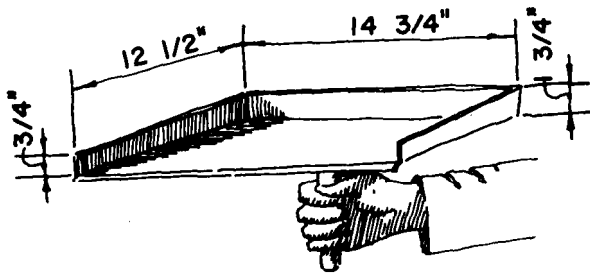

Figure Z.-Homemade hawk designed especially for surface-bonding work.

## FOUNDATION

A concrete block building, like any building, needs a solid foundation laid on undisturbed or well-compacted soil. A level foundation or floor is the most important requirement before starting the first course of block. High and low points should be within one-fourth inch of level in any 10-foot length of the foundation or floor. Follow the general design requirements for depth of foundation and use of reinforcing in your area.

In some areas-and for all basements- a separate footing and foundation wall will be needed (fig. 3). Foundation wall thicknesses

and depths allowable below grade (below ground level) for nonreinforced, hollow concrete block walls, based on FHA minimum standards for average soil conditions, are as follows:

| <i>Foundation wall thickness</i> | <i>Maximum depth below grade</i> |
|----------------------------------|----------------------------------|
| 8"                               | 5'                               |
| 12"                              | 7'                               |

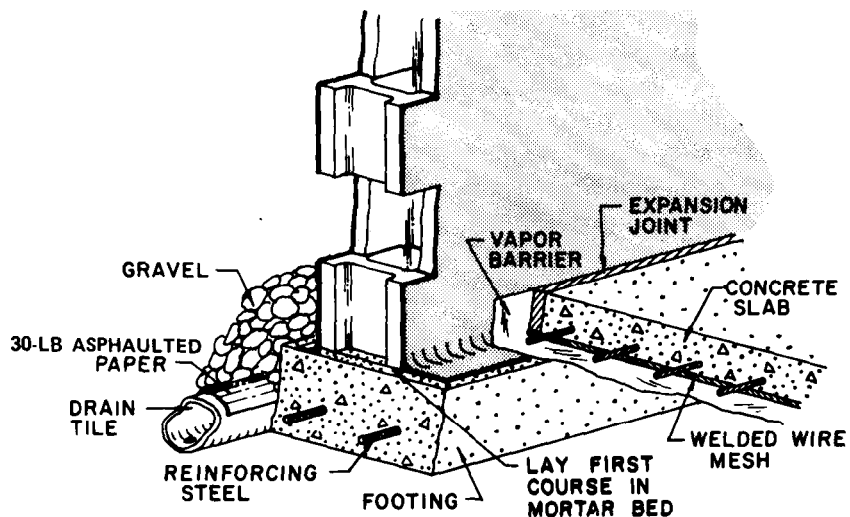

Figure 3.-Footings should be twice as wide as the wall thickness. Install drain tile adjacent to the footing to prevent buildup of water pressure against foundation. Cover open drain tile joints with 30-pound asphalted roofing felt. Backfill over tile with 12 inches of coarse gravel.

## TIE-DOWN RODS

In surface bonding construction, tie-down rods are fastened to the foundation. They are not needed for wall strength. Rather, they serve to tie the wood plate on top of the wall to the foundation. This provides better anchorage for the roof structure than does the conventional method of setting relatively short plate bolts into the concrete-filled top two or three courses of blocks.

**Tie-down** rods can be attached to the floor or foundation with expansion bolts. The easiest and fastest method to install these bolts is to drill holes into the floor or foundation with a hammer-type concrete drill after the concrete has hardened (fig. 4). An ordinary electric drill with a masonry bit may also be used. Expansion bolts are then expanded in the holes after the concrete has cured for at least 7 days.

Tie-down rods should be installed not more than 6 feet apart along exterior walls. In high wind areas, space tie-down rods not more than 4 feet apart. Rods should also run down through the block cores adjacent to each side of a door opening, and at building corners on each side.



Figure 4.—Drilling to install expansion bolts. Preliminary placement of the first course of blocks without bedding them in mortar enables the builder to accurately position bolts in the centers of block cores. A bubble mounted on the drill to aid in drilling the holes vertically may be used in place of the drilling guide shown. The guide cannot be used if the first course of blocks has already been bedded in mortar.

## FLOOR

If a concrete floor is used, it is important to complete all rough plumbing before pouring. If the floor is poured separately from the footing, install expansion joints as shown in figure 3.

A concrete slab floor on grade may be used in some areas (fig. 5). Specify **3,000-pound** concrete in place of the **2,500-pound** concrete most often used. Although it is slightly more expensive, the **3,000-pound** concrete works much more easily and is less liable to crack. Note reinforcing in figures 3 and 4; common practice that provides good results in your area should be followed.

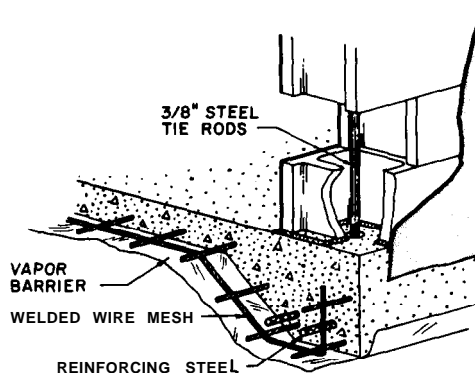

Figure 5.—Concrete slab floor on grade. Install bolts for tie-down rods.

## ERECTING THE WALLS

Unless prohibited by the building code, 8-inch-thick block walls may be used in one-story, single-family dwellings when the height of the wall does not exceed 9 feet at the plate line and 15 feet at the peak of any gable;

8-inch-thick walls must be used for two-story houses.<sup>4</sup> The basement is included as one

<sup>4</sup>HUD Minimum Property Standards for One- and Two-Family Dwellings.

story. (See tabulation on page 4 and section entitled "Basement Construction" for required thickness of basement walls.) Lightweight blocks bond best and are strong enough for two-story construction.

Stretch mason's lines to the dimensions of the building and at the proper height to align the first course of blocks. Lay the first course of blocks in rich mortar mixed by volume as follows: masonry cement-1 part; portland cement-1/2 part; and sand- 2 1/2 parts (fig. 6). Use a stiff mixture if a thick mortar bed is needed to level the first course. To avoid settling, allow the mortar to set up before stacking additional courses.

Lay succeeding courses of blocks without mortar. The tops of most blocks are somewhat rough. Slide the blocks back and forth a couple of times over other blocks to knock off excess material and burrs before stacking them,

Stack the blocks three courses high at corners and plumb (fig. 7). Stretch mason's line between corners. Then fill in between corners and door and window openings with blocks (fig. 8). Repeat the procedure with another three courses of blocks.

High-quality blocks do not vary much in any dimension. Check the blocks before you buy them, and find a supplier who can furnish

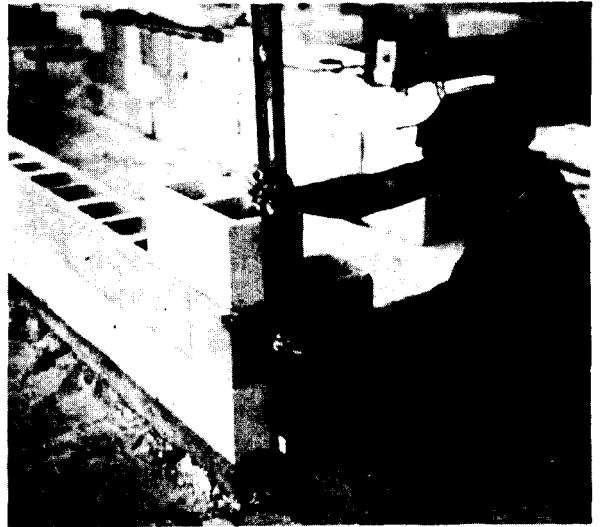

Figure 7.-Stack blocks at corners three courses high and plumb with mason's or carpenter's level.



Figure B.-Lay the first course of blocks in rich mortar on the slab floor or footing.



Figure 8.-Mason's line held between corners with wooden hooks. Lay wall without mortar to line.



uniform blocks. Blocks that are not dimensionally true may be plumbed and leveled by inserting flat sheet-metal shims or brick ties between them (fig. 9). Do not use *wood shims or spacers*. If the height of the blocks varies by more than one-eighth inch, bed the short blocks in mortar or bonding mix to correct the excessive height difference.

Use sash blocks with slotted ends to form the sides of window and door openings. The side fins on metal windows or the stops on wooden windows and door frames fit into the slots to hold windows and doors in place.

### Tying Intersecting Walls

Walls that intersect should be tied together to strengthen the walls against lateral pressures. Properly constructed intersections can serve as pilasters. (See section on pilasters, page 13 ).

The corners of exterior walls can be constructed integrally-i.e., with the conventional saw-toothed or interlocking arrangement of header blocks extending alternately from each side of the intersection. This type of construction should involve exterior walls only.

Intersections of partition walls with exterior walls should be reinforced with metal straps, or tie-bars. The procedure is essentially the same as with conventional block wall construction.



Figure 9.—Insert metal shims between blocks if necessary to level or plumb the wall.

The ends of the tie-bars-turned down about 4 inches—are set into block cores filled with mortar or concrete. However, since there are no mortar joints in surface bonding, the webs of the blocks must be notched in order to “bed” the tie-bars. (fig. 10).

### Control Joints

Control joints, always running the full height of the wall, may be required to prevent cracking in long concrete block walls. They are normally used in climates where temperatures vary widely, causing considerable expansion and contraction of the walls. The local experience of architects, engineers, and reputable builders as to the need for control joints is a practical guide. Generally, these joints are spaced 20 to 30 feet apart.

Special attention should be given to control joints in the design of residences to avoid an undesirable appearance. For example, control joints can sometimes be hidden behind downspouts.

A wooden panel, such as might be used in installing a door, will serve as a control joint (fig. 11). The blocks should not be stacked too

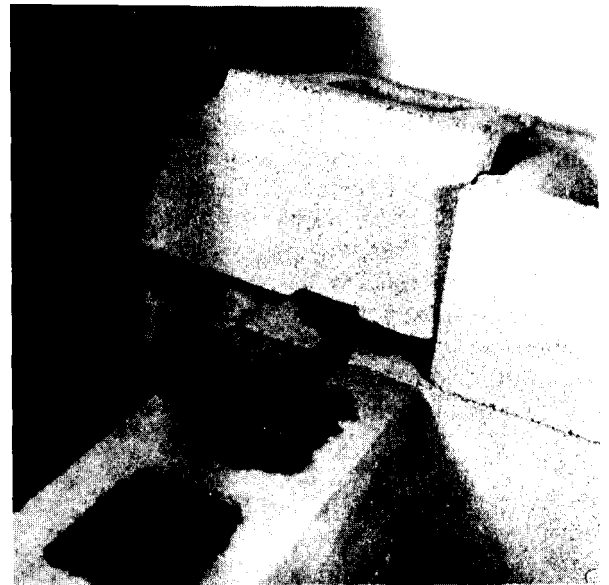

Figure 10.—Tie bars set in block cores filled with concrete or mortar to tie intersecting walls together.



Figure 11.-Wooden door panel, if it runs the full height of the wall as shown, may serve as a control joint. Photograph shows paper covering on the panel to prevent staining when surface bonding is applied to wall.

tightly against the wooden panel. Fill the exterior joints between the panel and blocks with a flexible caulking to seal against rain and wind. In residences or farm and commercial buildings, control joints may also be made in the wall (fig. 12) or at pilasters. Preformed gaskets and special blocks are also available to make control joints.

Wood frames for suspended floors should not press tightly against concrete block walls. Otherwise, swelling of the wood in high humidity combined with contraction of the block walls in winter may cause walls to crack.

### Lintels and Sills

Install lintels and sills in surface-bonded walls as you would in building with conventional mortar joints. Precast reinforced-concrete lintels (fig. 13) or steel angles are normally used. Special bond beam or lintel blocks are available in some localities. Rein-

forcing bars are inserted in these blocks, which are then filled with concrete to make strong lintels (fig. 14). The lintels need not be set in mortar. Apply surface bonding over the faces of the lintels to provide a finish matching the Wall.

### Windows and Doors

Windows and doors may be prefabricated into wood frame panels designed to fill the exact space that would be occupied by several whole blocks (fig. 15). For example, a **three-block** space normally measures 3 feet 10 <sup>7</sup>/<sub>8</sub> inches. Allow a full 3-foot 11-inch opening so the panels **will** not fit too tightly.

Fasten wooden stops or steel channels to the sides of the panels to fit into slots in the sash blocks forming the sides of the window and door openings.

Staple expanded metal to the interior side of the panel (except for the window or door opening) so that it can be surface-bonded, giving a uniform interior wall finish around and between all windows and doors. The surface bonding will not adhere to most building boards without the expanded metal covering.

An outside facing for the panels of **3/8-inch**, stained, exterior plywood with a **channel-groove**, striated, or rough-sawn surface makes a reasonably priced and durable finish. **One-fourth-inch** plywood is adequate for the interior. Glue and nail the plywood to the wood frame. An adhesive applied to framing members with a caulking gun is the easiest and fastest method of gluing. On window panels let the plywood extend downward over the concrete sills on the outside to provide a drip edge.

To secure the panel in the wall, drive nails through the top plate into the top of the panel, and fit the window panel over a concrete sill at the floor. These procedures will result in firmly fixed window panels.

Fasten door panels similarly. A weather-stripped threshold will brace the door frame at the floor.

Electrical outlets can be more easily installed in a wood frame panel than in a concrete block wall. The wiring can be connected before the interior finish is applied. Lead the wiring through the plate at the top, and leave a sufficient length to tie into a connection box.

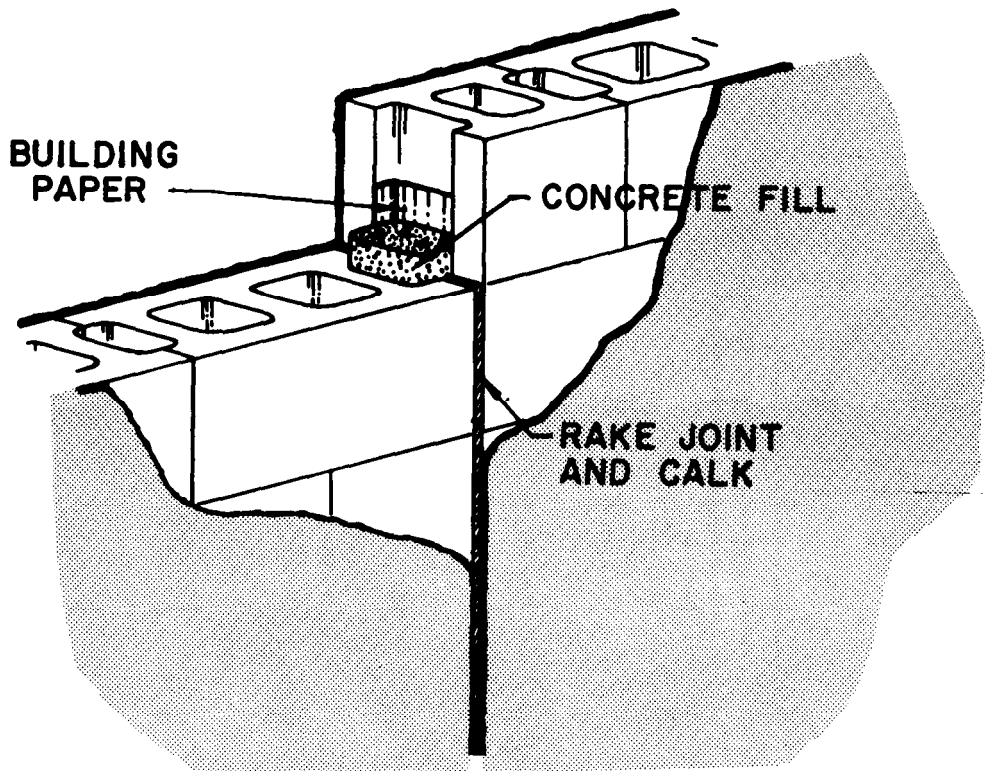

Figure 12.—One type of control joint. The joint must extend the full height of the wall.

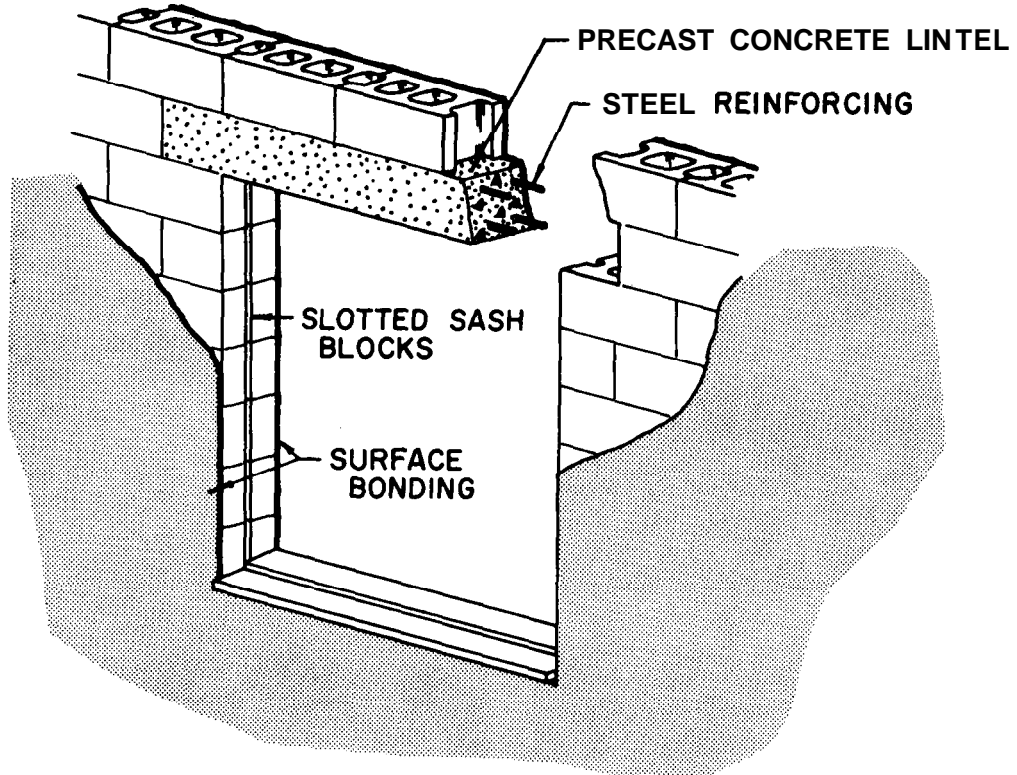

Figure 13.—Precast reinforced-concrete lintel.

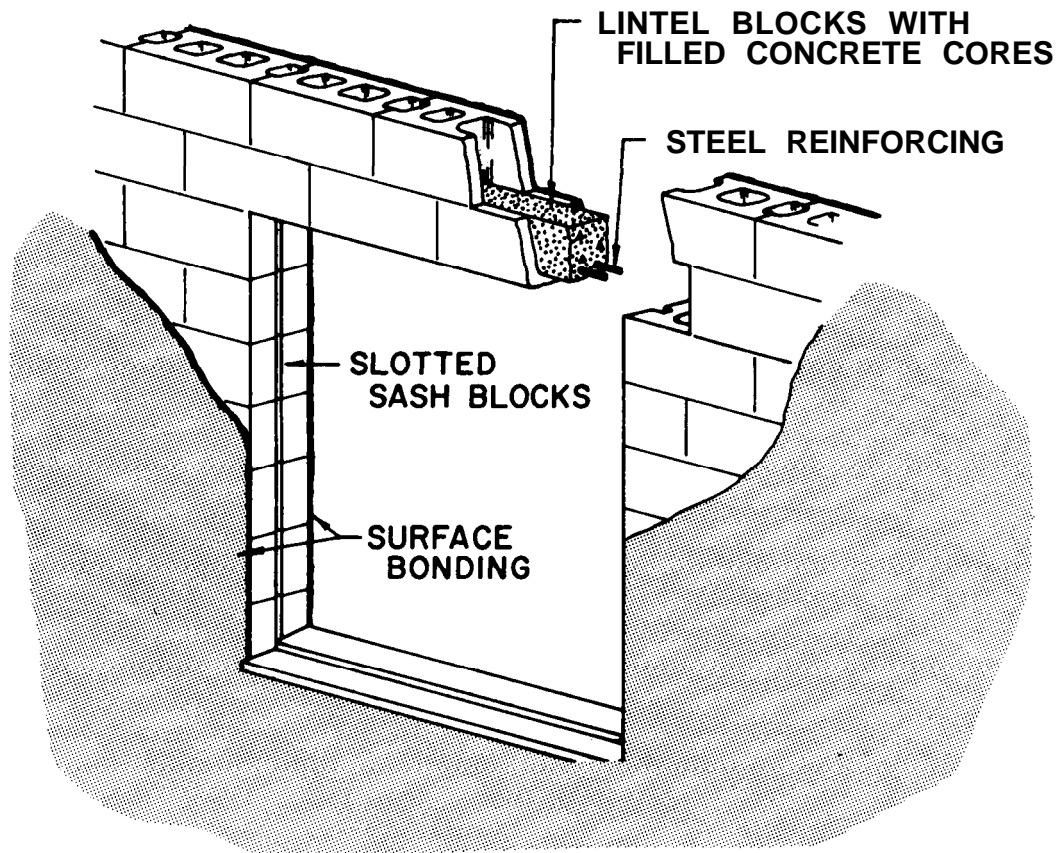

Figure 14.—Lintel made from bond beam or lintel blocks. Provide with reinforcing bars and fill with concrete as shown.



Figure 15.—Prefabricated wood frame window panel with exterior finish of rough-sawn plywood.

Concrete blocks may be cut to provide openings for standard-size windows. Several sizes of standard windows can be installed in the walls without cutting blocks. Other sizes may be ordered specially. Direct installation of windows in block walls will eliminate the wooden panels. This can reduce construction time and cost.

#### Installing Electrical Switches and Outlets

Electrical switches and outlets to be placed in the walls should be installed as the walls are being stacked. Saw openings in the block shell to fit the electrical boxes (fig. 16). Use a portable power saw equipped with a special carborundum blade for sawing concrete. Lightweight blocks are much easier to saw than regular sand-cement blocks. Fasten the electrical box in the cut opening with machine screws through the threaded holes in the box (fig. 17).

When electrical blocks are stacked in the

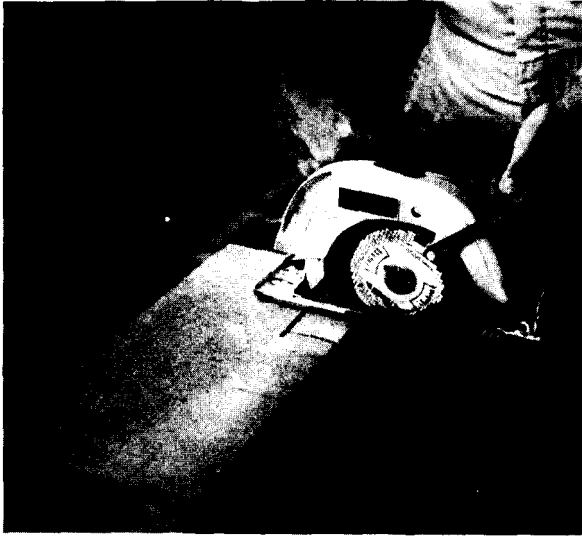

Figure 16.-Saw openings in the concrete block to mount an electrical switch or outlet box.

wall, remove one or more knockouts as needed. Insert a puller wire through the knockout hole long enough to reach above the top of the wall. Feed the wire through the cores above as the blocks are stacked. Nonmetallic sheathed cable can be fed through the cores and the box; the cable should be long enough to extend through a hole in the plate and reach a central box for connection to other outlets and the distribution panel. Type NM cable can be used where there is not excessive moisture or dampness. Type NMC or UF must be used in damp or wet situations.

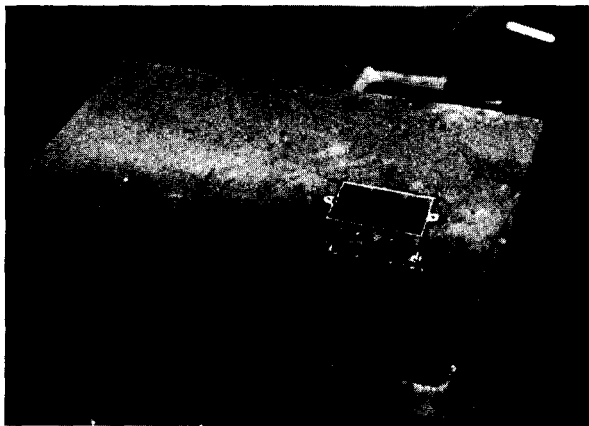

Figure 17.-Electrical outlet box mounted in sawed opening in concrete block. Box is fastened into block with 8/32 machine screws with slotted heads.

## Installing Tie-Down Rods

Figure the length of 3/8-inch-diameter tie-down rods measured to include the height of the stacked-block wall, plus one layer of 1/2-inch-thick asphalt-impregnated fiberboard (seals against rain and wind between the plate and the top of the concrete blocks), plus the thickness of the plate (one or two thicknesses of lumber). Add 2 inches to this calculated length to allow for bedding the first course in mortar and for variations in block height.

Thread three-fourths to 1-inch of one end of the rod. Thread three inches of the other end. Screw a rod connector, similar to a pump rod connector, onto the short-thread end of the rod. Lower the rod, connector-end down, into the block core. With a flashlight locate the tie-down bolt, and screw the connector onto it (fig. 18).

## Insulating the Wall

Fill appropriate core spaces with insulation before installing the plate and before surface bonding the wall. Pellet insulation such as perlite or expanded mica is the best insulation for this purpose. The insulation is treated with a silicone to resist moisture absorption. Products of this type on the market usually contain

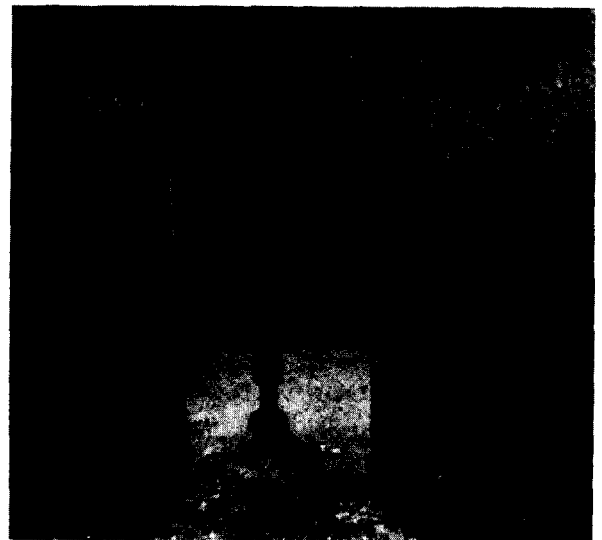

Figure 18.-Attach connector end of rod to the tie-down bolt set into the concrete footing or floor slab.

a large percentage of fine particles that tend to flow out of the cracks between the blocks before the surface bonding is applied. To avoid this, specify that at least 85 percent of the particles are to be retained on a No. 8 screen. A rectangular metal funnel can speed up filling the cores and avoid wasting the insulation (fig. 19). It can be made by any sheet-metal shop to fit the width of the wall.

An 8-inch thick wall made of surface-bonded, lightweight blocks with insulated cores has a heat transmission resistance, R, of 5.8 or an overall U coefficient for the web in an S-inch-thick block of 0.273. In cold climates, where the design temperature is -10° F, condensation will likely form on the interior block surface at the web when the relative humidity in the house reaches 60 percent. Insulation, in addition to the core type, will be needed in severely cold climates. An insulation board and an interior finish may be applied to the wall with an adhesive. Furring strips may be nailed to the wall, blanket or batt insulation applied between strips, and an interior finish attached.

### Installing the Plate

Saw strips of 1/2-inch-thick, asphalt-impregnated fiberboard the same width as the block wall. The fiberboard will conform to the top of the blocks in the wall and seal against wind and rain.

Drill holes in the fiberboard and wood plate at the proper places for the tie-down rods and



**Figure 19.—Filling cores of concrete block wall with pellet insulation. Rectangular metal funnel made to fit the width of the wall reduces the filling time and avoids spillage.**

electrical cables. Insert the rods and cables through these holes, and place a washer and nut on each rod. Tighten each nut firmly, but not with excessive pressure. Allow the concrete foundation or floor slab to cure at least 7 days before tightening the nuts. Often the forms are left on for a week. By the time the walls are stacked, the concrete will have cured enough so that the nuts can be tightened before the surface bonding is applied.

## BASEMENT CONSTRUCTION

Surface-bonded concrete block walls are highly water resistant and are therefore excellent for basement construction. Surface bonding eliminates the cement plastering (pargeting) required on the outside of ordinary mortar-joint walls. In some locations the foundation below ground tends to be unstable because of very wet spots or soil variations ranging from rock to wet clay. In these situations the application of asphalt and plastic flim over the

surface bonding may provide added safety against water leakage if the wall cracks.

The below-ground depth of nonreinforced surface-bonded basement walls should not exceed the FHA minimum property standards given on page 4 . For greater depths below ground, add vertical reinforcing in concrete-filled block cores or increase the wall thickness as required by FHA or by the building code applying to the particular locality.

## OTHER CONSTRUCTION DETAILS

### Pilasters

Pilasters built into the wall, intersecting partition walls, and comer walls furnish lateral support in a long horizontal span. Pilasters are generally needed to support heavily loaded center beams in a building.

The construction and spacing of pilasters for surface-bonded concrete block walls is the same as for standard mortar-joint construction

(fig. 20). The horizontal spacing is usually 18 times the thickness of the wall.

### Beams or Joists

Beams, or joists, that are supported by surface-bonded block walls must have a bearing of at least 3 inches on solid masonry (fig. 21). When the solid masonry is precast, the sections should be bedded in mortar on the supporting block beneath.

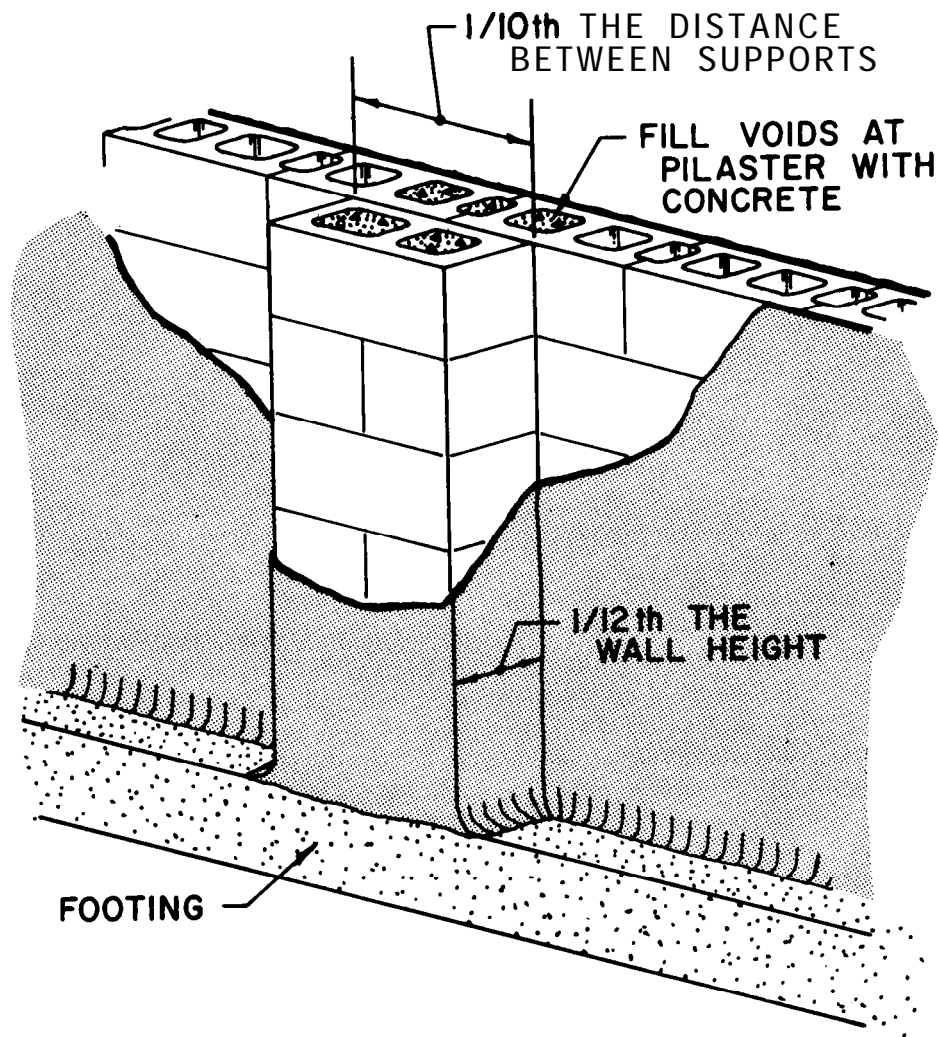
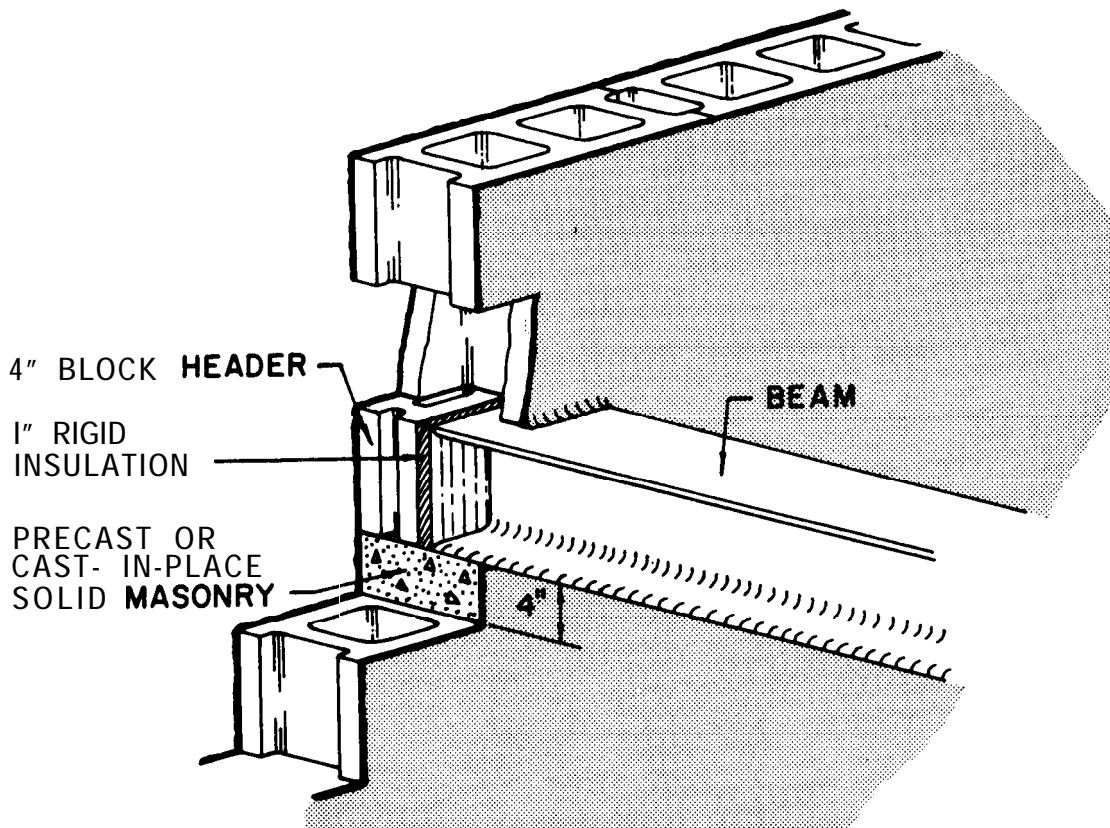

Figure 20.—A typical pilaster for strengthening a wall or supporting a beam.



**Figure 21.**—Supporting joist, or beam, in a surface-bonded wall. Reinforce block cores beneath beam with steel rods and concrete as required by building code.

## SURFACE BONDING THE WALLS

### Commercial Surface Bonding Premixes

Dry, premixed surface bonding is now being packaged by a number of firms and is available on the retail market. Building material dealers, concrete products plants, and paint stores will be stocking these products as they become more widely used. The bag sizes range from 25 to 80 pounds. Some premixes require only the addition of water. Others have a small plastic envelope filled with calcium chloride inside the bag. The calcium chloride should be mixed with water before making the wet mix. Some premixes contain sand and should be applied one-eighth inch thick. Those without sand need to be applied only one-sixteenth inch thick. Follow the manufacturer's directions on the package.

The price of commercial premixes may run as much as three times the cost of ingredients

for home mixing. However, the commercial products are accurately proportioned and eliminate most of the labor of mixing. They also eliminate the need to locate ingredients, some of which are sold only in large quantities.

Inspect the premix before using it to be sure that the fibers are well distributed; if they are not, remix. Also, inspect for frayed glass strands. If there is a large amount of frayed strands in several of the packages, do not accept the commercial premix. It will be difficult to mix and apply. Try to get packages from a different batch, as manufacturers are experimenting to get proper control in mixing their product.

Remix as little as possible. Too much mixing frays the strands or separates the strands into individual filaments. This makes proper application of the bonding mix difficult.



## Ingredients for Home-Mixed Surface Bonding

The ingredients for home-mixed surface bonding are as follows:

- Portland cement (normally packaged in **94-pound** sacks). White cement is more expensive than regular gray cement but is less alkaline, has a more finished appearance, and needs less mineral coloring for pastel shades if you desire to color the mix. It is preferred for all uses, but regular type-1 gray cement is sometimes used.

- Hydrated lime (normally packaged in **50-pound** sacks). Hydrated lime makes the mixture more workable and easier to apply. Lime with lowest alkaline content is made from pure dolomitic limestone.

- Calcium chloride (normally packaged in **100-pound** sacks), in flake or crystal form. Calcium chloride makes the mixture set up quicker and results in a harder surface. It is available from agricultural chemical dealers and from **distributors** handling it for ice and snow removal.

- Calcium stearate (normally packaged in **50-pound** boxes). Calcium stearate makes the mix waterproof. Use a wettable technical grade, generally available from chemical distributors.

- Glass fiber filament chopped into one half-inch lengths (normally packaged in **40- or 50-pound** boxes). Type E fiber, coated with silane or chrome organic binder, is available from plastic and chemical supply distributors. An alkali-resistant fiber, type K, may be available from building material dealers and plastic products dealers. The glass fiber acts as reinforcement in the mixture to give it strength and prevent cracking.

### Home Mixing the Materials

The bonding mix sets rapidly after the water and calcium chloride have been added to the dry ingredients, especially in hot weather. If one person is plastering, prepare only 25 pounds of bonding mix at one time.

The weights of the ingredients needed to make a 25-pound batch (dry weight) of the bonding mix are as follows:

| <i>Ingredient</i>      | <i>Parts</i> | <i>Pounds</i> |
|------------------------|--------------|---------------|
| Cement .....           | 78           | 19 1/2        |
| Lime .....             | 15           | 3 3/4         |
| Calcium stearate ..... | 1            | 1/4           |
| Glass Fiber .....      | 4            | 1             |
| Calcium chloride ..... | 2            | 1/2           |
| Total .....            | 100          | 25            |

Mix-in dry form—the cement, lime, and calcium stearate thoroughly. Add the glass fiber and remix only long enough to distribute the fibers well. Too much stirring tends to break up the strands into individual filaments. When this happens, the bonding mix is hard to apply.

If mortar or concrete coloring is to be used, blend it into the dry mixture of cement, lime, and calcium stearate before the fibers are added. Dark colors are not recommended because they tend to splotch and fade. Even with light colors, weigh each batch carefully to avoid differences in color tone from batch to batch.

Mix the calcium chloride with 1 gallon of water. Add this solution slowly to the dry ingredients and mix thoroughly. Add about one-half gallon more of water. You may need to adjust this amount of water slightly to produce the right consistency for good troweling. The mix should have a creamy consistency—as thin as possible but not too thin to prevent handling with a trowel. Most people tend to make it too stiff. It will then be hard to apply and may not bond properly.

Mixing can be done by hand in a wheelbarrow or small mortar box. A garden cultivator rake or weeding hoe (three- or four-tine) works best. Check the mix with your hands for lumps. Wear rubber gloves to avoid possible burning of the skin.

A power-driven plasterer's mixer can be used (fig. 22). Put the water-calcium chloride solution in the mixer first and add the dry mix slowly.

If the mix becomes too stiff before it can be completely used, add a small amount of water. Do not add water more than 30 minutes after

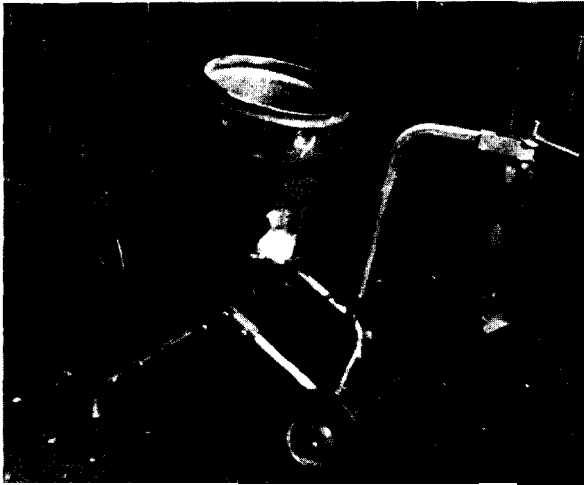

**Figure 22.—Motor-driven plasterer's mixer for mixing small batches of surface bonding. The cylindrical metal container rotates against a rubber or plastic blade, creating a scraping action that does not cause the fibers to "ball up" as with other types of mixers.**

the initial mixing because it weakens the bond. Discard such remixed batches whenever the material again becomes too stiff to apply on a wet wall.

Batches of the dry ingredients can be mixed well in advance so that there will be no delay in preparing the mix when it is time to begin the bonding operation. If the dry mix is to be stored several weeks, place each batch in a plastic or multiwall paper bag and close the top tightly. Weigh out the calcium chloride for each batch and seal it in a separate plastic bag; do not mix it with the dry ingredients.

### Applying the Bonding Mix

**Surface-bond both sides of the wall.** It will not be strong enough if the bonding mix is applied on only one side.

The blocks must be free of dirt, loose sand, cement, and paint. If necessary, clean the blocks with a wire brush when they are dry.

Spray the wall with water until it is wet but not dripping.

Work the mix from a hawk onto the wall

with a plasterer's trowel (fig. 23). Hold the hawk against the wall to avoid excessive spilling of the mix.

A very thin coat about one-sixteenth inch thick of the bonding mix is all that is necessary.

Work from the top of the wall downward. Thus, if the uncoated portion of the wall needs rewetting, the water will not run over freshly applied bonding.

Most workers can cover a section about 5 feet wide standing in one position. Start applying the bonding 2 or 3 feet from the top of the wall and trowel the mix upward to the plate. Move down another 2 or 3 feet and repeat the process, blending the freshly covered section into the bottom of the section above.

There are four essential steps in successfully applying and finishing the bonding:

1. Apply the mix with firm trowel pressure, pushing the load upward and outward until a fairly uniform coverage is attained.
2. Follow with longer, lighter strokes, holding the face of the trowel at a very slight angle to the surface (about 5°) to even up



**Figure 23.—Work the bonding mix from a hawk onto the wall with a plasterer's trowel. Note the specially made hawk with turned-up edges on three sides to prevent spilling the relatively thin mix.**

the plastered area and to spread excess bonding mix to fringe areas.

3. Move to the area below and apply mix as in steps 1 and 2. Continue bonding for 15 to 20 minutes, or until you have covered 25 to 30 square feet of surface.
4. Dip the trowel in water to clean it. Retrowel the first area, holding the trowel at a slight angle as in step 2. With firm pressure and long strokes, sweep over the area only enough to smooth out any unevenness.

Too much retroweling may cause hairline cracks, or crazing. In addition, a slightly fibrous texture has a more pleasing appearance and hides unevenness in the surface better than does a very smooth surface.

A calcamine brush may be used to obtain a pleasing, brush surface in place of the troweling described in step 4. Brushing must be done with light strokes immediately following step 3, before the mix begins to set. In hot, dry weather brushing may need to be done on smaller areas immediately after step 2. Use either horizontal or vertical strokes depending on the surface effect desired. When the brush begins to drag because of mix collecting in the bristles, dip the brush in water and shake out the excess. This will probably have to be done after brushing an area of 10 or 15 square feet.

A stippled surface may be obtained with a paint roller from which the fibers have been burned off with a torch. The fibers melt, leaving nubs on the roller surface. Follow the same procedure as described for obtaining a brushed surface.

If the bonding application must be stopped for 30 to 45 minutes or more, try to stop at a corner or at the edge of a window or door opening, particularly when color has been added to the mix. Color differences that might occur between batches will then be less apparent.

Fill in the corner junction between the wall and footing, carrying the bonding mix onto the top of the footing on both sides of the wall (as illustrated in fig. 20). If the wall is built on a concrete slab floor on grade, carry the surface bonding down over the outside edge of the slab to help seal the joint between wall and floor (previously indicated in fig. 5).

Wet the finished bonding with a fine spray of water once or twice the first day to aid curing.

Roof construction can begin 24 hours after the bonding is completed, but a longer waiting period is desirable. Erecting the roof before applying the surface bonding is advisable because interior work can be done during inclement weather. Also, the added weight of the roof helps to seat blocks in the wall firmly.

### **Coverage of the Bonding Mix**

Twenty-five pounds (dry weight) of bonding mix should cover at least 60 square feet of wall, or about 30 square feet of wall bonded on both sides.

### **Time Requirements**

The time required to erect and complete surface-bonded walls will depend on such factors as the levelness of the floor or foundation on which the walls are to be erected, the building experience and skill of the workers, the quality of the concrete blocks (particularly uniformity of dimensions), and the building design—specifically, the number of window and door openings and offsets in the walls which involve interior corners. However, a conservative average would be 5.0 man-hours per 100 blocks for stacking and 2.5 man-hours per 100 blocks for surface bonding.

### **Sanded Bonding Mix**

If a sanded surface is desired, add 1 part of sand by weight to 1 part of regular bonding mix (dry weight). This must be applied one-eighth inch thick to give adequate strength and waterproofing. The cost will be slightly higher than the unsanded formulation previously described. Use a clean white sand such as that sold for playpens; about 100 percent should pass a No. 10 screen and 75 percent should pass a No. 20 screen. The same amount of water is needed for 50 pounds of sanded mix as for 25 pounds of unsanded mix.

## PAINING SURFACE-BONDED WALLS

Surface-bonded walls are easy to paint. Although not required for waterproofing purposes (except in swimming pools and in tanks over 4 feet deep), painting can be used to improve the appearance of badly soiled walls or to change the color scheme.

Paints developed especially for use on masonry are recommended for painting surface-bonded walls. Usually these paints have a latex base and are thinned with water. The acrylic-type latex base is best, especially for exterior use.

### CAUTION

Surface bonding has been thoroughly tested as a construction technique for erecting block walls without mortar joints. However, because of the comparative newness of surface bonding, the requirements, standards, and specifications for its use are still evolving. ***The materials and procedures recommended in this publication are not necessarily in compliance with all Federal Government specifications on the use of surface bonding in Federally approved housing.*** This applies to housing financed or approved by the Farmers Home Administration, the Federal Housing Administration, the Veterans Administration, and other government agencies. ***Prospective applicants for Federal assistance should carefully examine the requirements of the lending agency as they pertain to surface bonding.***

U.S. GOVERNMENT PRINTING OFFICE : 1976 O-207-707

Washington, D.C.

Issued October 1974

For sale by the Superintendent of Documents, U.S. Government Printing Office  
Washington, D.C. 20402 • Price 45 cents

25% discount allowed on orders of 100 or more to one address

Stock No. 001-000-03340-9/Catalog No. A 1.75:374

There is a minimum charge of \$1.00 for each mail order